

1W isolated DC-DC converter  
Fixed input voltage and unregulated single output



UL<sup>®</sup> CE CB Patent Protection RoHS

### FEATURES

- Continuous short-circuit protection
- No-load input current as low as 5mA
- Operating ambient temperature range: -40°C to +105°C
- High efficiency up to 85%
- Compact SMD package
- I/O isolation test voltage 1.5k VDC
- Industry standard pin-out
- IEC62368, UL62368, EN62368 approved

B05\_XT-1WR3 series are specially designed for applications where an isolated voltage is required in a distributed power supply system. They are suitable for: pure digital circuits, low frequency analog circuits, relay-driven circuits and data switching circuits.

### Selection Guide

Certification	Part No.	Input Voltage(VDC)	Output		Full Load Efficiency(%) Min./Typ.	Capacitive Load(μF) Max.
		Nominal ( Range )	Voltage (VDC)	Current(mA) Max./Min.		
UL/CE/CB	B0503XT-1WR3	5 (4.5-5.5)	3.3	303/30	70/74	2400
	B0505XT-1WR3		5	200/20	78/82	2400
	B0509XT-1WR3		9	111/12	79/83	1000
	B0512XT-1WR3		12	84/9	79/83	560
	B0515XT-1WR3		15	67/7	79/83	560
	B0524XT-1WR3		24	42/4	81/85	220

### Input Specifications

Item	Operating Conditions	Min.	Typ.	Max.	Unit	
Input Current (full load / no-load)	5VDC input	3.3VDC/5VDC output	--	270/5	286/10	mA
		9VDC/12VDC output	--	241/12	254/20	
		15VDC/24VDC output	--	241/18	254/30	
Reflected Ripple Current*		--	15	--	mA	
Surge Voltage (1sec. max.)	5VDC input	-0.7	--	9	VDC	
Input Filter		Capacitance filter				
Hot Plug		Unavailable				

Note: \* Refer to DC-DC Converter Application Notes for detailed description of reflected ripple current test method.

### Output Specifications

Item	Operating Conditions	Min.	Typ.	Max.	Unit	
Voltage Accuracy		See output regulation curve (Fig. 1)				
Linear Regulation	Input voltage change: ±1%	3.3VDC output	--	--	1.5	%
		Other outputs	--	--	1.2	
Load Regulation	10%-100% load	3.3VDC output	--	15	20	%
		5VDC output	--	10	15	
		9VDC output	--	8	10	
		12VDC output	--	7	10	
		15VDC output	--	6	10	
		24VDC output	--	5	10	

Ripple & Noise*	20MHz bandwidth	Other outputs	--	30	75	mVp-p
		24VDC output	--	50	100	
Temperature Coefficient	Full load		--	±0.02	--	%/°C
Short-circuit Protection			Continuous, self-recovery			

Note: \* The "parallel cable" method is used for Ripple and Noise test, please refer to DC-DC Converter Application Notes for specific information.

### General Specifications

Item	Operating Conditions	Min.	Typ.	Max.	Unit
Isolation	Input-output Electric Strength Test for 1 minute with a leakage current of 1mA max.	1500	--	--	VDC
Insulation Resistance	Input-output resistance at 500VDC	1000	--	--	MΩ
Isolation Capacitance	Input-output capacitance at 100kHz/0.1V	--	20	--	pF
Operating Temperature	Derating when operating temperature ≥ 100°C, (see Fig. 2)	-40	--	105	°C
Storage Temperature		-55	--	125	
Case Temperature Rise	Ta=25°C	3.3VDC output	--	25	
		Other outputs	--	15	--
Storage Humidity	Non-condensing	--	--	95	%RH
Reflow Soldering Temperature		Peak temp. ≤ 245°C, maximum duration time ≤ 60s over 217°C.			
Switching Frequency	Full load, nominal input voltage	--	270	--	KHz
MTBF	MIL-HDBK-217F@25°C	3500	--	--	K hours
Moisture Sensitivity Level (MSL)	IPC/JEDEC J-STD-020D.1	Level 1			

Note: \* For actual application, please refer to IPC/JEDEC J-STD-020D.1.

### Mechanical Specifications

Case Material	Black plastic; flame-retardant and heat-resistant (UL94 V-0)
Dimensions	13.20 x 11.40 x 7.25 mm
Weight	1.4g(Typ.)
Cooling methods	Free air convection

### Electromagnetic Compatibility (EMC)

Emissions	CE	CISPR32/EN55032 CLASS B (see Fig. 4 for recommended circuit)
	RE	CISPR32/EN55032 CLASS B (see Fig. 4 for recommended circuit)
Immunity	ESD	IEC/EN61000-4-2 Air ±8kV, Contact ±4kV perf. Criteria B

### Typical Characteristic Curves

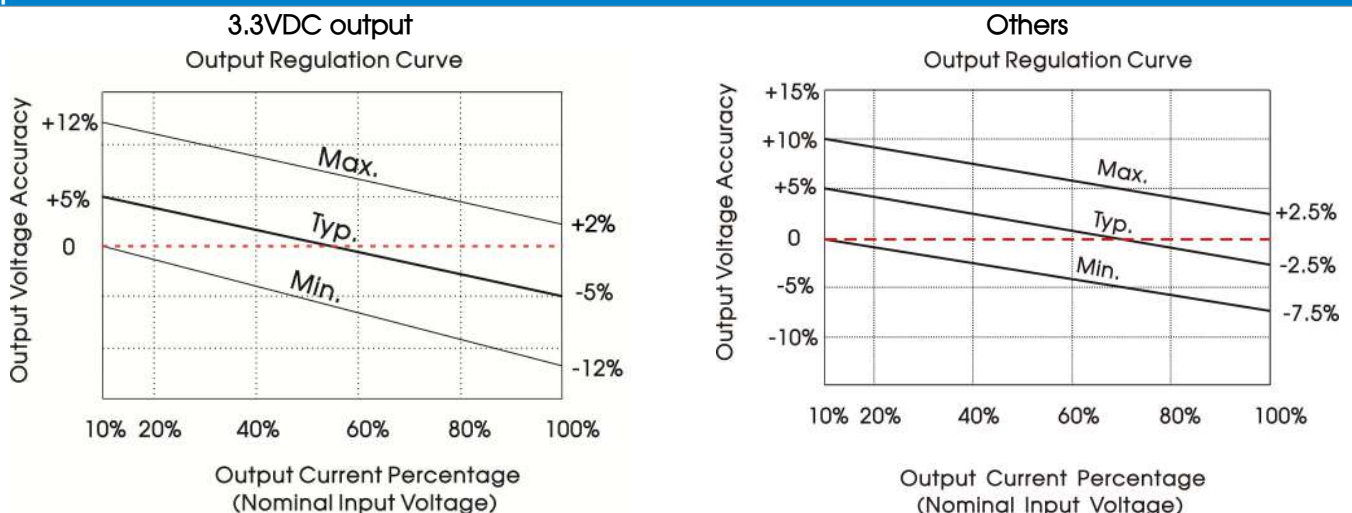

Fig. 1

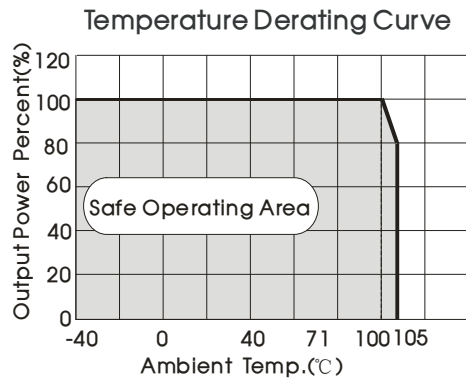
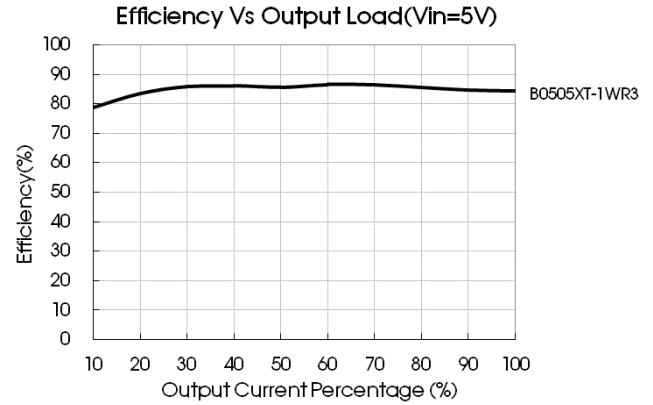
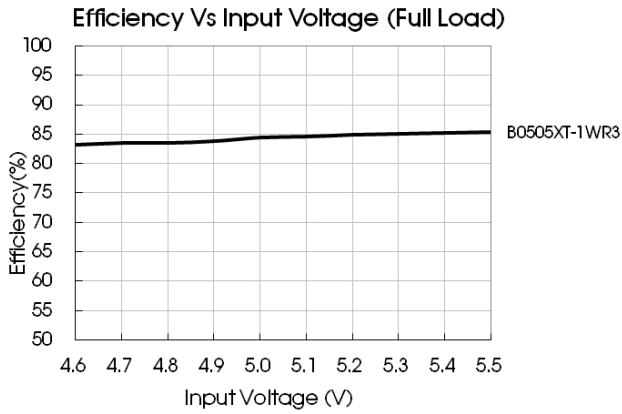

Fig. 2

Design Reference

1. Typical application circuit

Input and/or output ripple can be further reduced, by connecting a filter capacitor from the input and/or output terminals to ground as shown in Fig. 3.

Choosing suitable filter capacitor values is very important for a smooth operation of the modules, particularly to avoid start-up problems caused by capacitor values that are too high. For recommended input and output capacitor values refer to Table 1.

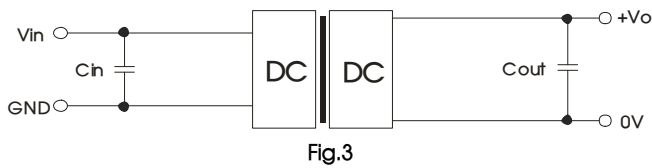

Fig.3

Recommended capacitive load value table (Table 1)

Vin(VDC)	Cin(μF)	Vo (VDC)	Cout(μF)
5	4.7	3.3/5	10
		9	4.7
		12	2.2
		15	1
		24	0.47

2. EMC (CLASS B) compliance circuit

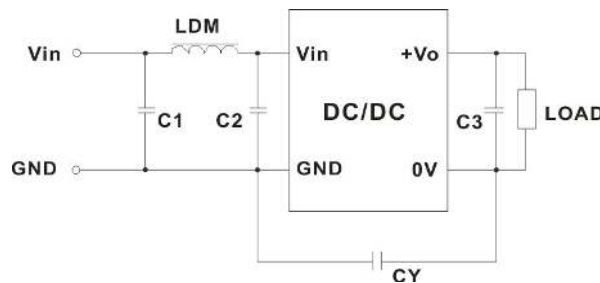

Fig. 4

EMC recommended circuit value table (Table 2)

Input voltage 5VDC	Output voltage(VDC)		3.3/5/9	12/15/24
	EMI	C1/C2		4.7μF /25V
CY			--	1nF/2KVDC HEC C1206X102K202T JOHANSON 202R18W102KV4E
C3			Refer to the Cout in table 1	
LDM			6.8μH	6.8μH

Note: In the case of actual use, the requirements for EMI are high, it is subject to CY.

3. For additional information please refer to DC-DC converter application notes on [www.mornsun-power.com](http://www.mornsun-power.com).

Dimensions and Recommended Layout

THIRD ANGLE PROJECTION

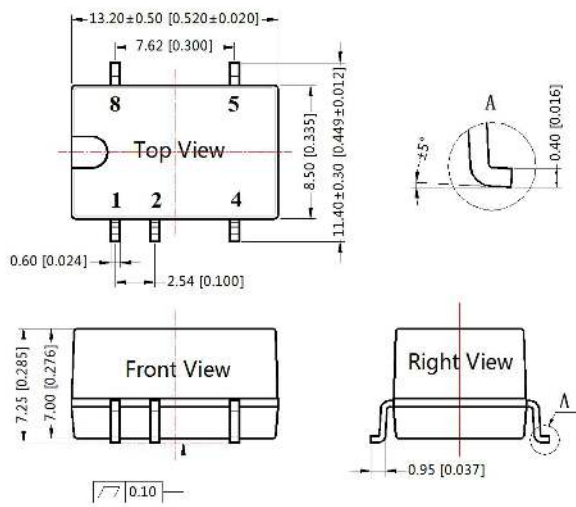

Note:  
Unit: mm[inch]  
Pin section tolerances: ±0.10[±0.004]  
General tolerances: ±0.25[±0.010]

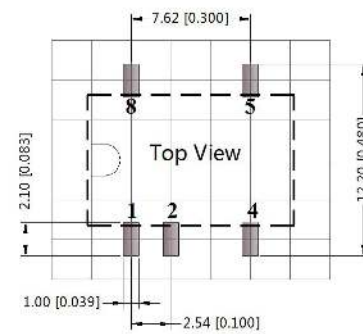

Note: Grid 2.54\*2.54mm

Pin-Out	
Pin	Function
1	GND
2	Vin
4	0V
5	+Vo
8	NC

NC: Pin to be isolated from circuitry

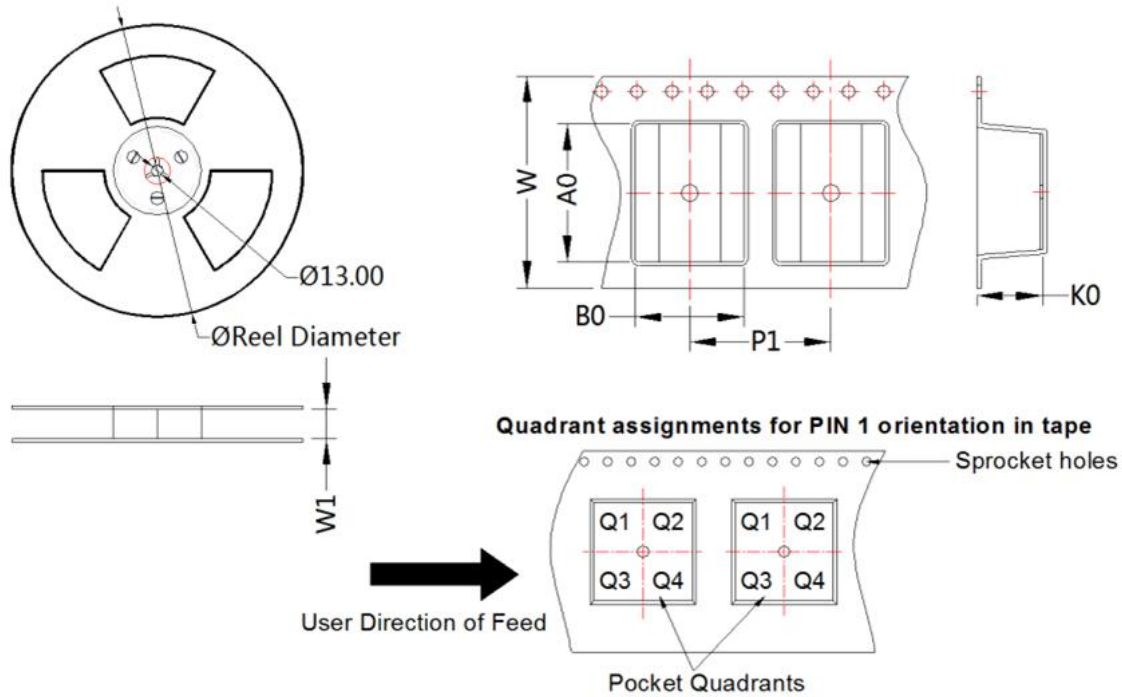

Device	Package Type	Pin	SPQ	Reel Diameter (mm)	Reel Width W1 (mm)	A0 (mm)	B0 (mm)	K0 (mm)	P1 (mm)	W (mm)	Pin1 Quadrant
B05_XT-1WR3	SMD	5	500	330.0	24.5	13.4	11.7	7.5	16.0	24.0	Q1

Notes:

1. For additional information on Product Packaging please refer to [www.mornsun-power.com](http://www.mornsun-power.com). Tube Packaging bag number: 58210024, Roll Packaging bag number: 58200054;
2. If the product is not operated within the required load range, the product performance cannot be guaranteed to comply with all parameters in the datasheet;
3. The maximum capacitive load offered were tested at input voltage range and full load;
4. Unless otherwise specified, parameters in this datasheet were measured under the conditions of  $T_a=25^{\circ}\text{C}$ , humidity<75%RH with nominal input voltage and rated output load;
5. All index testing methods in this datasheet are based on our company corporate standards;
6. We can provide product customization service, please contact our technicians directly for specific information;
7. Products are related to laws and regulations: see "Features" and "EMC";
8. Our products shall be classified according to ISO14001 and related environmental laws and regulations, and shall be handled by qualified units.

MORNSUN Guangzhou Science & Technology Co., Ltd.

Address: No. 5, Kehui St. 1, Kehui Development Center, Science Ave., Guangzhou Science City, Huangpu District, Guangzhou, P. R. China  
 Tel: 86-20-38601850 Fax: 86-20-38601272 E-mail: [info@mornsun.cn](mailto:info@mornsun.cn) [www.mornsun-power.com](http://www.mornsun-power.com)