



DC/DC CONVERTER

- 24V DC-Input
- Isolated 24Vdc Output
- Efficiency 94.2%
- Width only 42mm
- 20% Output Power Reserves
- Full Power Between -25°C and +60°C
- Soft-start Function
- Minimal Inrush Current Surge
- Reverse Input Polarity Protection
- 3 Year Warranty

GENERAL DESCRIPTION

The CD10.241 is a DIN-rail mountable DC/DC converter of the DIMENSION series which provides a floating, stabilized and galvanically separated SELV/PELV output voltage.

The CD-Series is part of the DIMENSION power supply family. The most outstanding features of CD10.241 are the high efficiency, the small size and the wide operational temperature range.

The CD-Series includes all the essential basic functions. The devices have a power reserve of 20% included, which may even be used continuously at temperatures up to +45°C.

High immunity to transients and power surges as well as low electromagnetic emission and a large international approval package for a variety of applications makes this unit suitable for nearly every situation.

SHORT-FORM DATA

Output voltage	DC 24V	
Adjustment range	24 - 28V*)	
Output current	12 – 10.3A	Below +45°C amb.
	10 – 8.6A	At +60°C ambient
	7.5 – 6.5A	At +70°C ambient
Derate linearly between +45°C and +70°C		
Input voltage	DC 24V	-25%/+46%
Input voltage range	18 to 35Vdc	
Input current	typ. 10.5A	At 24Vdc input
Input inrush current	typ. 6A peak	At 25°C
Efficiency	94.2%	At 24Vdc input
Losses	14.8W	At 24Vdc input
Temperature range	-25°C to +70°C	
Hold-up time	4ms	At 24Vdc input
Size (W x H x D)	42x124x117mm	Without DIN-rail
Weight	500g / 1.1lb	

*) extended guaranteed adjustment range down to 23V.

ORDER NUMBERS

DC/DC Converter	CD10.241	
Accessory	ZM2.WALL	Wall mount bracket
	ZM12.SIDE	Side mount bracket
	YR20.246	Redundancy module

MARKINGS



INDEX

	Page		Page
1. Intended Use	3	20. Physical Dimensions and Weight	17
2. Installation Requirements.....	3	21. Accessories	18
3. Input Voltage	4	21.1. ZM2.WALL - Wall Mounting Bracket.....	18
4. Input Inrush Current and Soft-start Behavior	5	21.2. ZM12.SIDE - Side Mounting Bracket.....	18
5. Output	6	21.3. YR20.246 Redundancy Module	19
6. Hold-up Time.....	7	22. Application Notes.....	20
7. Efficiency and Power Losses.....	8	22.1. Peak Current Capability	20
8. Functional Diagram.....	9	22.2. Back-feeding Loads	21
9. Front Side and User Elements.....	9	22.3. Inductive and Capacitive Loads.....	21
10. Terminals and Wiring.....	10	22.4. Charging of Batteries	21
11. Lifetime Expectancy	11	22.5. External Input Protection.....	21
12. MTBF	11	22.6. Requirements for the Supplying Source..	22
13. EMC.....	12	22.7. Series Operation	22
14. Environment	13	22.8. Parallel Use to Increase Output Power	23
15. Protection Features	14	22.9. Parallel Use for Redundancy	23
16. Safety Features	14	22.10. Use in a Tightly Sealed Enclosure	24
17. Dielectric Strength	15	22.11. Mounting Orientations	25
18. Approvals.....	16		
19. RoHS, REACH and Other Fulfilled Standards ...	16		

The information given in this document is correct to the best of our knowledge and experience at the time of publication. If not expressly agreed otherwise, this information does not represent a warranty in the legal sense of the word. As the state of our knowledge and experience is constantly changing, the information in this data sheet is subject to revision. We therefore kindly ask you to always use the latest issue of this document (available under www.pulspower.com). No part of this document may be reproduced or utilized in any form without our prior permission in writing.

TERMINOLOGY AND ABBREVIATIONS

PE and \oplus symbol	PE is the abbreviation for Protective Earth and has the same meaning as the symbol \oplus .
Earth, Ground	This document uses the term "earth" which is the same as the U.S. term "ground".
T.b.d.	To be defined, value or description will follow later.
DC 24V	A figure displayed with the AC or DC before the value represents a nominal voltage with standard tolerances included. E.g.: DC 12V describes a 12V battery disregarding whether it is full (13.7V) or flat (10V)
24Vdc	A figure with the unit (Vac) at the end is a momentary figure without any additional tolerances included.

1. INTENDED USE

This device is designed for installation in an enclosure and is intended for the general use such as in industrial control, office, communication, and instrumentation equipment.

Do not use this device in equipment where malfunction may cause severe personal injury or threaten human life.

2. INSTALLATION REQUIREMENTS

This device may only be installed and put into operation by qualified personnel.

This device does not contain serviceable parts. The tripping of an internal fuse is caused by an internal defect.

If damage or malfunction should occur during installation or operation, immediately turn power off and send unit to the factory for inspection.

Mount the unit on a DIN-rail so that the output terminals are located on top and input terminal on the bottom. For other mounting orientations see de-rating requirements in this document.

This device is designed for convection cooling and does not require an external fan. Do not obstruct airflow and do not cover ventilation grid (e.g. cable conduits) by more than 30%!

Keep the following installation clearances: 40mm on top, 20mm on the bottom, 5mm on the left and right sides are recommended when the device is loaded permanently with more than 50% of the rated power. Increase this clearance to 15mm in case the adjacent device is a heat source (e.g. another DC/DC converter).

The input must be powered from a SELV source (according to IEC 60950-1), a PELV source (according to IEC 62477-1) or an Isolated Secondary Circuit (according to UL 508).

WARNING

Risk of electrical shock, fire, personal injury or death.

- Turn power off before working on the device. Protect against inadvertent re-powering.
- Make sure that the wiring is correct by following all local and national codes.
- Do not modify or repair the unit.
- Do not open the unit as high voltages may present inside.
- Use caution to prevent any foreign objects from entering the housing.
- Do not use in wet locations or in areas where moisture or condensation can be expected.
- Do not touch during power-on, and immediately after power-off. Hot surface may cause burns.

3. INPUT VOLTAGE

Input voltage	nom.	DC 24V	-25%/+46%
Input voltage range		18.0-35.0Vdc	full specified
	max.	36.0Vdc	absolute maximum continuous input voltage with no damage to the DC/DC converter
Allowed voltage between input and earth	max.	60Vdc or 42.2Vac	in case the output voltage is not grounded.
Allowed input ripple voltage	max.	5Vpp	47Hz-500Hz, the momentary input voltage must always be within the specified limits.
Turn-on voltage	typ.	17.5Vdc	steady-state value, see Fig. 3-1
Shut-down voltage	typ.	15.5Vdc	steady-state value, see Fig. 3-1
Input current	typ.	10.5A 14,3A	at 24Vdc input and output 24V, 10A, see Fig. 3-3 at 18Vdc input and output 24V, 10A, see Fig. 3-3
Start-up delay	typ.	200ms	see Fig. 3-1
Rise time	typ.	200ms	0mF, 24V, constant current load 10A, see Fig. 3-2
	typ.	200ms	10mF, 24V, constant current load 10A, see Fig. 3-2
Turn-on overshoot	max.	250mV	see Fig. 3-2
Input capacitance	typ.	4 300μF	external capacitors on the input voltage bus are allowed without any limitations.

Fig. 3-1 Input voltage range

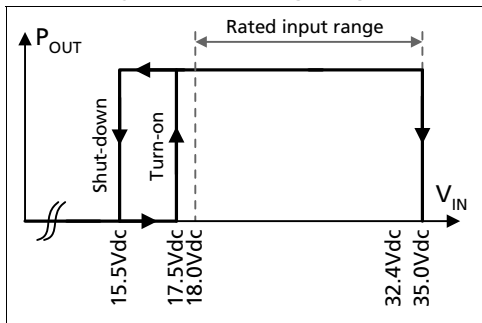

Fig. 3-2 Turn-on behavior, definitions

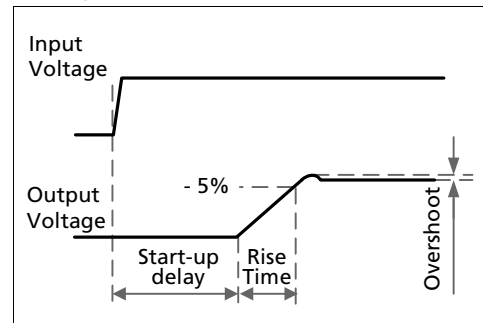
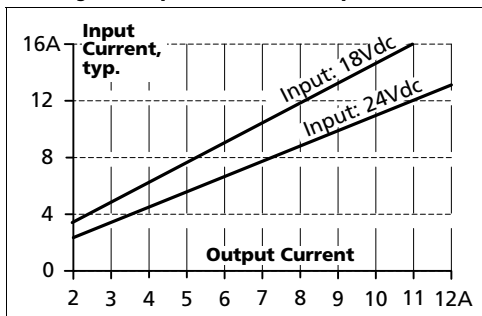

Fig. 3-3 Input current vs. output load



4. INPUT INRUSH CURRENT AND SOFT-START BEHAVIOR

Inrush current limitation

An active inrush limitation circuit (inrush limiting NTC resistor which is bypassed by a MOSFET) limits the input inrush current after turn-on of the input voltage.

The charging current into EMI suppression capacitors is disregarded in the first microseconds after switch-on.

Inrush current	typ.	6A _{peak}	+25°C, cold start, input: 24Vdc
	typ.	22A _{peak}	+60°C, cold start, input: 24Vdc
Inrush energy	typ.	negligible	-25°C to +70°C, input: 24Vdc

Fig. 4-1 Input inrush current, typical behavior

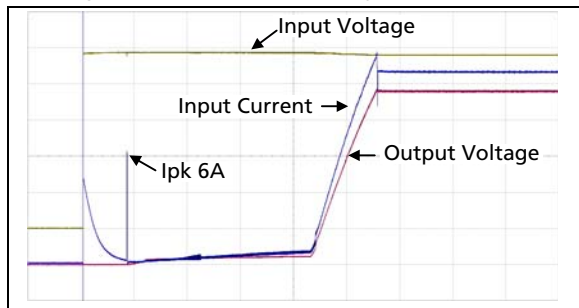

Input: 24Vdc
 Output: 24V, 10A, constant current load
 Ambient: 25°C

Input current 2A / DIV
 Input voltage 5V / DIV
 Output voltage 5V / DIV
 Time basis: 100ms / DIV

Soft-start function:

After the DC/DC converter is turned on, the internal output current rises slowly to its nominal value. This method charges the output capacitors (internal and external capacitors) slowly and avoids high input currents during turn-on. High input currents can produce a high voltage drop on the input wiring (especially with long and thin cables) which reduces the terminal voltage on the DC/DC converter. If the terminal voltage is below the shut-down voltage, the DC/DC converter will turn-off and will make a new start-up attempt. This effect is avoided with the integrated soft-start function. Please note, that this function increases the rise time of the output voltage by a small amount.

5. OUTPUT

Output voltage	nom.	24V	
Adjustment range	min.	24-28V	*)
	max.	30V	
Factory setting		24.1V	at clockwise end position of potentiometer ±0.2%, at full load, cold unit
Line regulation	max.	25mV	Input voltage variations between 18 to 35Vdc
Load regulation	max.	100mV	static value, 0A → 10A
Ripple and noise voltage	max.	50mVpp	20Hz to 20MHz, 50Ohm
Output capacitance	typ.	4 500µF	
Output current	nom.	12A	at 24V, ambient < +45°C, see Fig. 5-1
	nom.	10A	at 24V, ambient < +60°C, see Fig. 5-1
	nom.	7.5A	at 24V, ambient at +70°C, see Fig. 5-1
	nom.	10.3A	at 28V, ambient < +45°C, see Fig. 5-1
	nom.	8.6A	at 28V, ambient < +60°C, see Fig. 5-1
	nom.	6.5A	at 28V, ambient at +70°C, see Fig. 5-1
Output power	nom.	288W	for ambient temperatures < +45°C
	nom.	240W	for ambient temperatures < +60°C
	nom.	180W	at +70°C ambient temperature
Short-circuit current	min.	13A	continuous current, short circuit impedance 100mOhm
	max.	15A	continuous current, short circuit impedance 100mOhm

*) extended guaranteed adjustment range from 23V to 28V.

Fig. 5-1 **Output voltage vs. output current at 24Vdc input voltage, typ.**

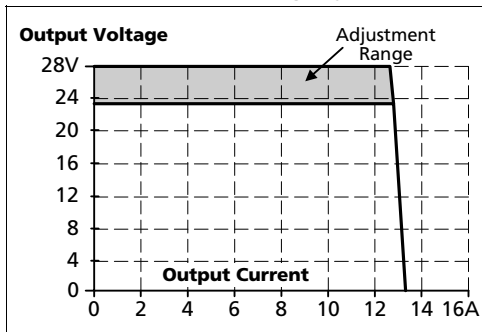
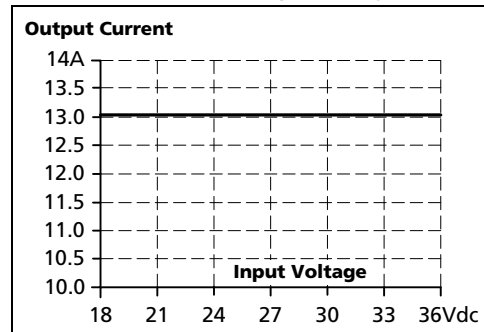

Fig. 5-2 **Current limitation vs. input voltage, (23V constant voltage load), typ.**



6. HOLD-UP TIME

The input side of the DC/DC converter is equipped with a bulk capacitor which keeps the output voltage alive for a certain period of time when the input voltage dips or is removed. The bulk capacitor can be discharged by loading the DC/DC converter on the output side or through a load which is parallel to the input. There is no protection in the DC/DC converter which prevents current from flowing back to the input terminals. If prevention is needed, an external diode should be used.

Hold-up Time	typ.	8ms	at 24Vdc input and 24Vdc, 5A output, see Fig. 6-1
	typ.	4ms	at 24Vdc input and 24Vdc, 10A output, see Fig. 6-1

Fig. 6-1 Hold-up time vs. input voltage

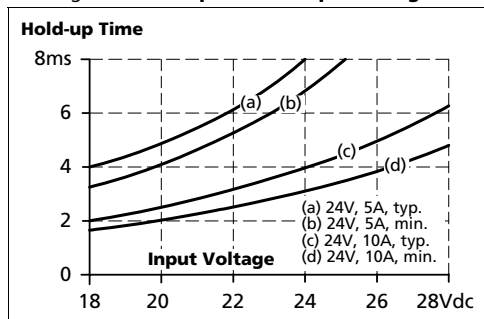

Fig. 6-2 Shut-down test setup

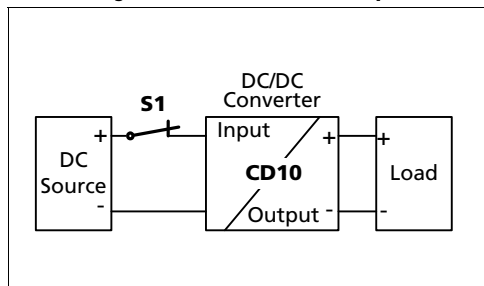
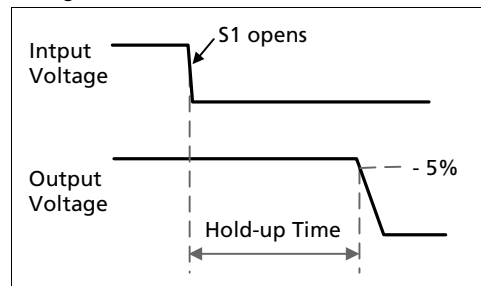

Fig. 6-3 Shut-down behavior, definitions



Note: At no load, the hold-up time can be up to several seconds. The green DC-ok lamp is also on during this time.

7. EFFICIENCY AND POWER LOSSES

Input 24Vdc			
Efficiency	typ.	94.2%	at 24V, 10A
	typ.	93.7%	at 24V, 12A (Power Boost)
Average efficiency*)	typ.	94.3%	25% at 2.5A, 25% at 5A, 25% at 7.5A. 25% at 10A
Power losses	typ.	1.75W	at no output load
	typ.	6.8W	at 24V, 5A
	typ.	14.7W	at 24V, 10A
	typ.	19.5W	at 24V, 12A

*) The average efficiency is an assumption for a typical application where the power supply is loaded with 25% of the nominal load for 25% of the time, 50% of the nominal load for another 25% of the time, 75% of the nominal load for another 25% of the time and with 100% of the nominal load for the rest of the time.

Fig. 7-1 Efficiency vs. output current at 24V output and 24Vdc input voltage, typ.

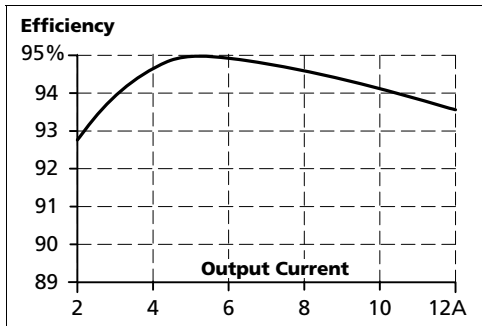

Fig. 7-2 Losses vs. output current at 24V output and 24Vdc input voltage, typ.

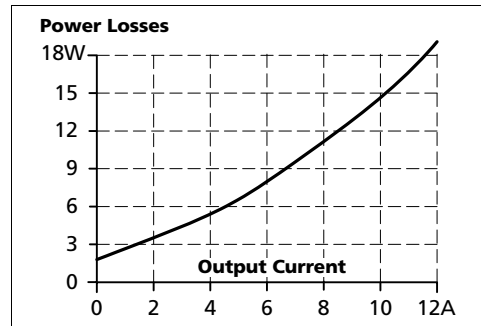

Fig. 7-3 Efficiency vs. input voltage at 24V, 10A, typ.

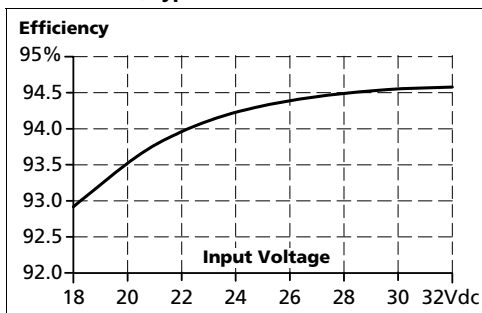
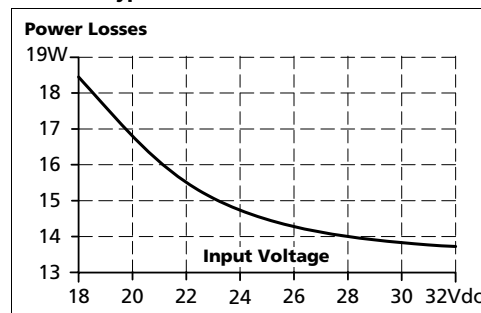
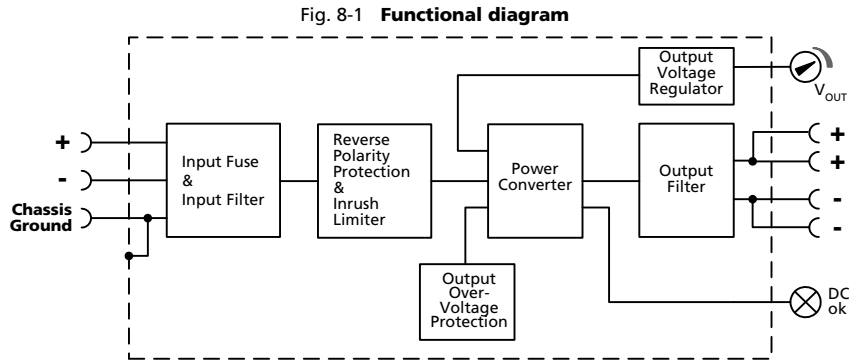

Fig. 7-4 Losses vs. input voltage at 24V, 10A, typ.



8. FUNCTIONAL DIAGRAM



9. FRONT SIDE AND USER ELEMENTS

Fig. 9-1 Front side



- A** Input terminals
Screw terminals
+ Positive input
- Negative (return) input
Chassis ground: can be used to bond the housing to PE
Ground this terminal to minimize high-frequency emissions.
- B** Output terminals
Screw terminals, dual terminals per pole, both pins are equal
+ Positive output
- Negative (return) output
- C** Output voltage potentiometer
Open the flap to set the output voltage. Factory set: 24.1V
- D** DC-OK LED (green)
On when the voltage on the output terminals is > 21V

10. TERMINALS AND WIRING

	Input	Output
Type	screw terminals	screw terminals
Solid wire	max. 6mm ²	max. 6mm ²
Stranded wire	max. 4mm ²	max. 4mm ²
American Wire Gauge	20-10 AWG	20-10 AWG
Max. wire diameter	2.8mm (including ferrules)	2.8mm (including ferrules)
Wire stripping length	7mm / 0.275inch	7mm / 0.275inch
Screwdriver	3.5mm slotted or Pozidrive No 2	3.5mm slotted or Pozidrive No 2
Recommended tightening torque	1Nm, 9lb.in	1Nm, 9lb.in

Instructions:

- a) Use appropriate copper cables that are designed for an operating temperature of:
 - 60°C for ambient up to 45°C and
 - 75°C for ambient up to 60°C and
 - 90°C for ambient up to 70°C minimum.
- b) Follow national installation codes and installation regulations!
- c) Ensure that all strands of a stranded wire enter the terminal connection!
- d) Screws of unused terminal compartments should be securely tightened.

Daisy chaining of outputs:

Daisy chaining (jumping from one DC/DC-converter output to the next) is allowed as long as the average output current through one terminal pin does not exceed 25A. If the current is higher, use a separate distribution terminal block.

Fig. 10-1 Daisy chaining of outputs

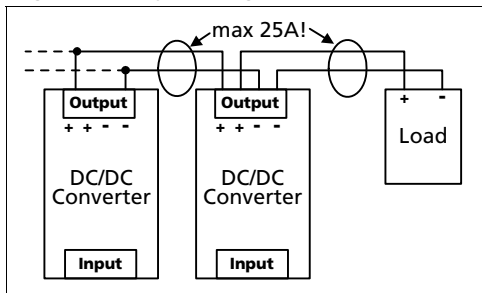
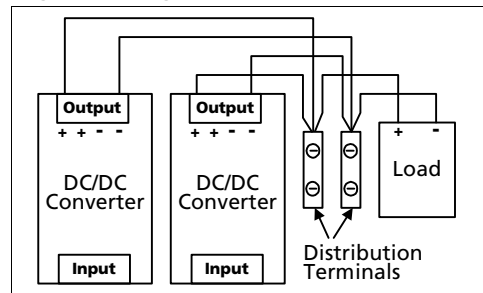

Fig. 10-2 Using distribution terminals



11. LIFETIME EXPECTANCY

The Lifetime expectancy shown in the table indicates the minimum operating hours (service life) and is determined by the lifetime expectancy of the built-in electrolytic capacitors. Lifetime expectancy is specified in operational hours and is calculated according to the capacitor's manufacturer specification. The manufacturer of the electrolytic capacitors only guarantees a maximum life of up to 15 years (131 400h). Any number exceeding this value is a calculated theoretical lifetime which can be used to compare devices.

	Input 24Vdc	
Lifetime expectancy	299 000h	at 24V, 5A and 40°C
	103 000h	at 24V, 10A and 40°C
	56 000h	at 24V, 12A and 40°C
	844 000h	at 24V, 5A and 25°C
	292 000h	at 24V, 10A and 25°C
	159 000h	at 24V, 12A and 25°C

12. MTBF

MTBF stands for **Mean Time Between Failure**, which is calculated according to statistical device failures, and indicates reliability of a device. It is the statistical representation of the likelihood of a unit to fail and does not necessarily represent the life of a product.

The MTBF figure is a statistical representation of the likelihood of a device to fail. A MTBF figure of e.g. 1 000 000h means that statistically one unit will fail every 100 hours if 10 000 units are installed in the field. However, it can not be determined if the failed unit has been running for 50 000h or only for 100h.

For these types of units the MTTF (**Mean Time To Failure**) value is the same value as the MTBF value.

	Input 24Vdc	
MTBF SN 29500, IEC 61709	731 000h	at 24V, 10A and 40°C
	1 321 000h	at 24V, 10A and 25°C
MTBF MIL HDBK 217F	358 000h	at 10A and 40°C; Ground Benign GB40
	556 000h	at 10A and 25°C; Ground Benign GB25
	731 000h	at 10A and 40°C; Ground Fixed GF40
	142 000h	at 10A and 25°C; Ground Fixed GF25

13. EMC

The DC/DC converter is suitable for applications in industrial environment as well as in residential, commercial and light industry environments.

EMC Immunity		According to generic standards EN 61000-6-1 and EN 61000-6-2.		
Electrostatic discharge	EN 61000-4-2	Contact discharge	8kV	Criterion A
		Air discharge	15kV	Criterion A
Electromagnetic RF field	EN 61000-4-3	80MHz-2.7GHz	20V/m	Criterion A
Fast transients (Burst)	EN 61000-4-4	Input lines	4kV	Criterion A
		Output lines	2kV	Criterion A
Surge voltage on input	EN 61000-4-5	+ → -	1kV	Criterion A
		+/- → chassis ground	2kV	Criterion A
Surge voltage on output	EN 61000-4-5	+ → -	500V	Criterion A
		+ / - → chassis ground	1kV	Criterion A
Conducted disturbance	EN 61000-4-6	0.15-80MHz	20V	Criterion A

Criteria:

- A:** DC/DC converter shows normal operation behavior within the defined limits.
- C:** Temporary loss of function is possible. DC/DC converter may shut-down and restarts by itself. No damage or hazards for the DC/DC converter will occur.

EMC Emission		According to generic standards EN 61000-6-3 and EN 61000-6-4.	
Conducted emission on input	IEC/CISPR 16-1-2, IEC/CISPR 16-2-1		Limits for DC power networks according to EN 61000-6-3 fulfilled
Radiated emission	EN 55011, EN 55022		Class B

This device complies with FCC Part 15 rules.

Operation is subjected to following two conditions: (1) this device may not cause harmful interference, and (2) this device must accept any interference received, including interference that may cause undesired operation.

Switching frequency	Variable between 50kHz and 300kHz depending on load and input voltage
----------------------------	---

14. ENVIRONMENT

Operational temperature ¹⁾	-25°C to +70°C (-13°F to 158°F)	reduce output power according Fig. 14-1
Storage temperature	-40 to +85°C (-40°F to 185°F)	for storage and transportation
Output de-rating	3.2W/°C 6W/°C	45-60°C (113°F to 140°F) 60-70°C (140°F to 158°F)
Humidity ²⁾	5 to 95% r.H.	IEC 60068-2-30
Vibration sinusoidal ³⁾	2-17.8Hz: ±1.6mm; 17.8-500Hz: 2g 2 hours / axis	IEC 60068-2-6
Shock ³⁾	30g 6ms, 20g 11ms 3 bumps / direction, 18 bumps in total	IEC 60068-2-27
Altitude	0 to 6000m (0 to 20 000ft)	reduce output power or ambient temperature above 2000m sea level.
Altitude de-rating	15W/1000m or 5°C/1000m	above 2000m (6500ft), see Fig. 14-2
Over-voltage category	not applicable	The concept of the overvoltage category is used for equipment energized directly from the low voltage mains (IEC 60664-1 §4.3.3.2.1).
Degree of pollution	2	IEC 62477-1, not conductive
LABS compatibility	The unit does not release any silicone or other LABS-critical substances and is suitable for use in paint shops.	
Corrosive gases	ISA-71.04-1985, Severity Level G3, IEC 60068-2-60 Test Ke Method 4	
Audible noise	Some small audible noise will be emitted from the power supply.	

- 1) Operational temperature is the same as the ambient temperature and is defined as the air temperature 2cm below the unit.
- 2) Do not energize while condensation is present
- 3) Tested in combination with DIN-Rails according to EN 60715 with a height of 15mm and a thickness of 1.3mm and standard mounting orientation. Higher levels allowed when using the wall mounting bracket ZM2.WALL.

Fig. 14-1 **Output current vs. ambient temp.**

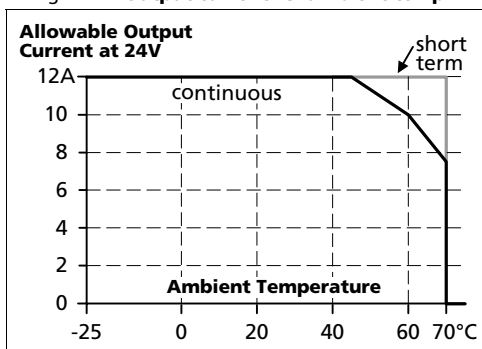
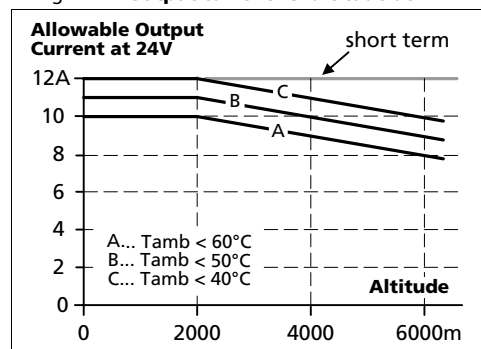

Fig. 14-2 **Output current vs. altitude at 24V**



15. PROTECTION FEATURES

Output protection	Electronically protected against overload, no-load and short-circuits. In case of a protection event, audible noise may occur.	
Output over-voltage protection	typ. 31Vdc max. 32.5Vdc	In case of an internal power supply defect, a redundant circuit limits the maximum output voltage. The output shuts down and automatically attempts to restart.
Reverse input polarity protection	Included	Unit does not start when input voltage is reversed
Output over-current protection	Electronically limited	See Fig. 5-1
Degree of protection	IP 20	According to EN/IEC 60529
Penetration protection	> 3.5mm	E.g. screws, small parts
Over-temperature protection	no	-
Input transient protection	MOV (Metal Oxide Varistor)	For protection values see chapter 13 (EMC)
Internal input fuse	Included	Not user replaceable slow-blow high-braking capacity fuse

16. SAFETY FEATURES

Classification of output voltage	SELV ¹⁾ PELV ¹⁾	According to IEC/EN 60950-1 According to IEC/EN 60204-1, IEC 62477-1, IEC 60364-4-41
Class of protection	III	PE (Protective Earth) connection not required. A connection of the "Chassis Ground" pin to earth is recommended for best EMI performance.
Isolation resistance	> 500MΩ	Input to output, 500Vdc
PE resistance	< 0.1Ω	Between housing and Chassis Ground terminal
Touch current (leakage current)	The leakage current, which is produced by the DC/DC converter itself, depends on the input voltage ripple and need to be investigated in the final application. For a smooth DC input voltage, the produced leakage current is less than 100µA.	

1) Provided, that the input voltage meets the requirements of chapter 2.

17. DIELECTRIC STRENGTH

The output voltage is floating and has no ohmic connection to the ground.

Type and factory tests are conducted by the manufacturer. Field tests may be conducted in the field using the appropriate test equipment which applies the voltage with a slow ramp (2s up and 2s down). Connect all input terminals together as well as all output poles before conducting the test.

When testing, set the cut-off current settings to the value in the table below.



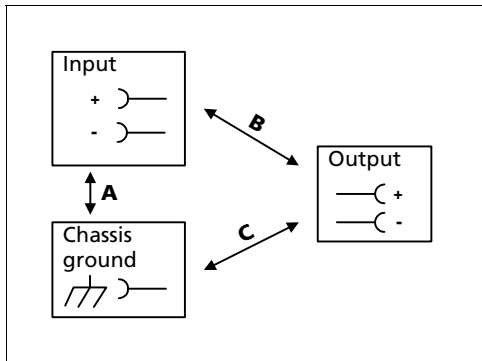





Fig. 17-1 Dielectric strength





		A	B	C
Type test	60s	1500Vac	1500Vac	500Vac
Factory test	5s	1500Vac	1500Vac	500Vac
Field test	5s	1000Vac	1000Vac	500Vac
Cut-off current setting		40mA	20mA	12mA

To fulfill the PELV requirements according to EN60204-1 § 6.4.1, we recommend that either the + pole, the - pole or any other part of the output circuit shall be connected to the protective earth system. This helps to avoid situations in which a load starts unexpectedly or can not be switched off when unnoticed earth faults occur.

18. APPROVALS

EC Declaration of Conformity		The CE mark indicates conformance with the - EMC directive and the - ATEX directive (planned).
IEC 60950-1 2 nd Edition planned		CB Scheme, Information Technology Equipment
UL 508 planned		LISTED for use as Industrial Control Equipment; U.S.A. (UL 508) and Canada (C22.2 No. 107-1-01); E-File: E198865
UL 60950-1 planned		RECOGNIZED for the use as Information Technology Equipment, Level 3; U.S.A. (UL 60950-1) and Canada (C22.2 No. 60950-1); E-File: E137006
EN 60079-0, EN 60079-7 ATEX planned	 II 3G Ex ec II T4 Gc	Approval for use in hazardous locations Zone 2 Category 3G. The device must be built-in in an IP54 enclosure.
IEC 60079-0, IEC 60079-7 planned		Suitable for use in Class 1 Zone 2 Groups IIa, IIb and IIc locations. Number of IECEx certificate: T.B.D.
ANSI / ISA 12.12.01-2007 Class I Div 2 planned		Recognized for use in Hazardous Location Class I Div 2 T4 Groups A,B,C,D systems; U.S.A. (ANSI / ISA 12.12.01) and Canada (C22.2 No. 213-M1987)
Marine planned		GL (Germanischer Lloyd) classified Environmental category: C, EMC2 Marine and offshore applications
EAC TR Registration		Registration for the Eurasian Customs Union market (Russia, Kazakhstan, Belarus)

19. ROHS, REACH AND OTHER FULFILLED STANDARDS

RoHS Directive		Directive 2011/65/EU of the European Parliament and the Council of June 8 th , 2011 on the restriction of the use of certain hazardous substances in electrical and electronic equipment.
REACH Directive		Directive 1907/2006/EU of the European Parliament and the Council of June 1 st , 2007 regarding the Registration, Evaluation, Authorisation and Restriction of Chemicals (REACH)
IEC/EN 61558-2-16 (Annex BB)	Safety Isolating Transformer	Safety Isolating Transformers corresponding to Part 2-6 of the IEC/EN 61558

20. PHYSICAL DIMENSIONS AND WEIGHT

Width	42mm 1.65"
Height	124mm 4.88"
Depth	117mm 4.61" The DIN-rail height must be added to the unit depth to calculate the total required installation depth.
Weight	500g / 1.10lb
DIN-Rail	Use 35mm DIN-rails according to EN 60715 or EN 50022 with a height of 7.5 or 15mm.
Housing material	Body: Aluminium alloy Cover: zinc-plated steel
Installation clearances	See chapter 2

Fig. 20-1 **Front view**

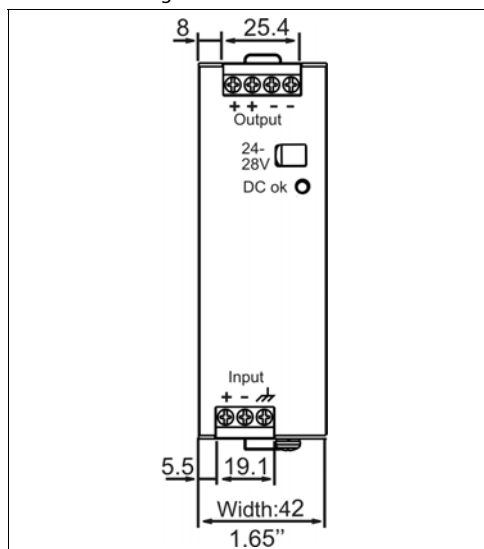
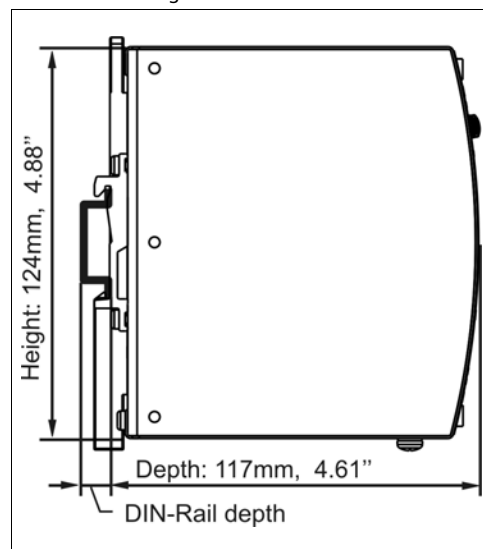

Fig. 20-2 **Side view**



21. ACCESSORIES

21.1. ZM2.WALL - WALL MOUNTING BRACKET

This bracket is used to mount the power supply onto a flat surface without utilizing a DIN-Rail.

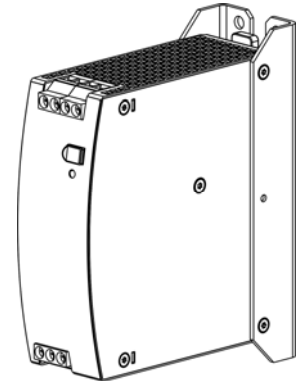
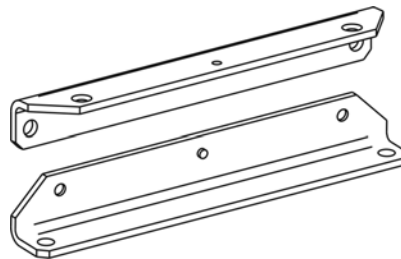

21.2. ZM12.SIDE - SIDE MOUNTING BRACKET

This bracket is used to mount DIMENSION units sideways with or without utilizing a DIN-Rail. The two aluminum brackets and the black plastic slider of the unit have to be detached, so that the steel brackets can be mounted.

For sideways DIN-rail mounting, the removed aluminum brackets and the black plastic slider need to be mounted on the steel bracket.

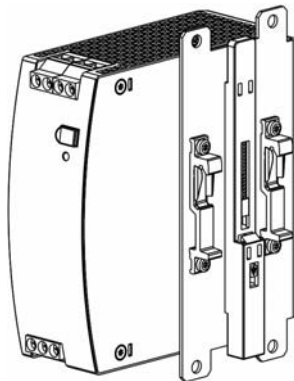

Side mounting with DIN-rail brackets

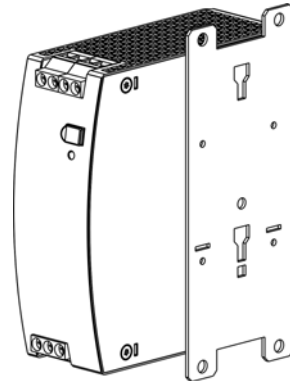

Side mounting without DIN-rail brackets

21.3. YR20.246 REDUNDANCY MODULE



The YR20.246 redundancy module is equipped with two input channels each 10A nominal, which are individually decoupled by utilizing MOSFET technology. The output can be loaded with nominal 20A. Using MOSFETs instead of diodes reduces the heat generation and the voltage drop between input and output.

The YR20.246 does not require an additional auxiliary voltage and is self-powered even in case of a short circuit across the output.

Due to the low power losses, the unit is very slender and only requires 32mm width on the DIN-rail.

The YR20.246 is equipped with a load share feature, which balance the load current between the two inputs of the redundancy module.

The "Load Share OK" and the "Redundancy OK" relay contacts enable a remotely alarming of critical situations. See chapter 22.9 for further wiring information.

22. APPLICATION NOTES

22.1. PEAK CURRENT CAPABILITY

The unit can deliver peak currents (up to several milliseconds) which are higher than the specified short term currents. This helps to start current demanding loads. Solenoids, contactors and pneumatic modules often have a steady state coil and a pick-up coil. The inrush current demand of the pick-up coil is several times higher than the steady-state current and usually exceeds the nominal output current (including the PowerBoost). The same situation applies when starting a capacitive load.

The peak current capability also ensures the safe operation of subsequent circuit breakers of load circuits. The load branches are often individually protected with circuit breakers or fuses. In case of a short or an overload in one branch circuit, the fuse or circuit breaker need a certain amount of over-current to open in a timely manner. This avoids voltage loss in adjacent circuits.

The extra current (peak current) is supplied by the power converter and the built-in large sized output capacitors of the power supply. The capacitors get discharged during such an event, which causes a voltage dip on the output. The following two examples show typical voltage dips:

Fig. 22-1 Peak loading with 2x the nominal current for 50ms, typ.

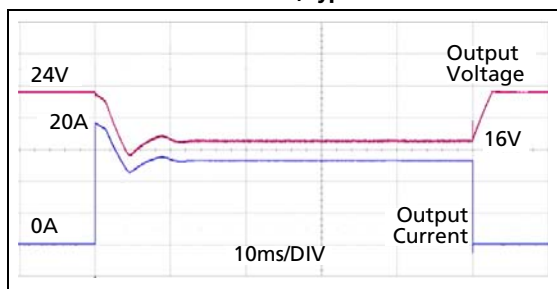

Peak load 20A (resistive load) for 50ms
Output voltage dips from 24V to 16V.

Fig. 22-2 Peak loading with 4x the nominal current for 5ms, typ.

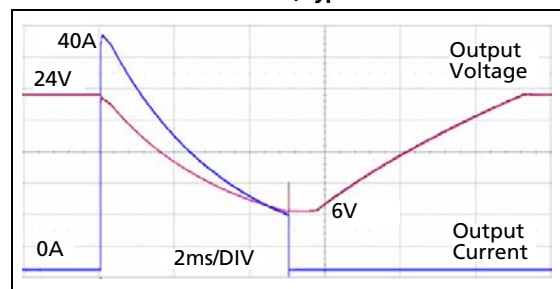

Peak load 40A (resistive load) for 5ms
Output voltage dips from 24V to 6V.

Peak current voltage dips	typ.	from 24V to 16V	at 20A for 50ms, resistive load
	typ.	from 24V to 12V	at 40A for 2ms, resistive load
	typ.	from 24V to 6V	at 40A for 5ms, resistive load

22.2. BACK-FEEDING LOADS

Loads such as decelerating motors and inductors can feed voltage back to the power supply. This feature is also called return voltage immunity or resistance against Back- E.M.F. (Electro Magnetic Force).

This power supply is resistant and does not show malfunctioning when a load feeds back voltage to the power supply. It does not matter whether the power supply is on or off.

The maximum allowed feed-back-voltage is 35Vdc. The maximum allowed feed-back peak current is 40A. Higher currents can temporarily shut-down the output voltage. The absorbing energy can be calculated according to the built-in large sized output capacitance which is specified in chapter 5.

22.3. INDUCTIVE AND CAPACITIVE LOADS

The unit is designed to supply any kind of loads, including unlimited capacitive and inductive loads.

22.4. CHARGING OF BATTERIES

The DC/DC converter can be used to charge lead-acid or maintenance free batteries. (Two 12V batteries in series)

Instructions for charging batteries:

- a) Ensure that the ambient temperature of the DC/DC converter is below 45°C
- b) Do not use DC/DC converters in mounting orientations other than the standard mounting orientation (input terminals on the bottom and output terminals on top of the unit).
- c) Set output voltage (measured at no load and at the battery end of the cable) very precisely to the end-of-charge voltage.

End-of-charge voltage	27.8V	27.5V	27.15V	26.8V
Battery temperature	10°C	20°C	30°C	40°C

- d) Use a 16A circuit breaker (or blocking diode) between the DC/DC converter and the battery.
- e) Ensure that the output current of the DC/DC converter is below the allowed charging current of the battery.
- f) Use only matched batteries when putting 12V types in series.
- g) The return current to the DC/DC converter (battery discharge current) is typ. 10mA when the DC/DC converter is switched off (except in case a blocking diode is utilized).

22.5. EXTERNAL INPUT PROTECTION

The unit is tested and approved for branch circuits up to 50A. An external protection is only required, if the supplying branch has an ampacity greater than this. Check also local codes and local requirements. In some countries local regulations might apply.

If an external fuse is necessary or utilized, minimum requirements need to be considered to avoid nuisance tripping of the circuit breaker. A minimum value of 20A B- or C-Characteristic breaker should be used.

22.6. REQUIREMENTS FOR THE SUPPLYING SOURCE

In certain circumstances, the input filter of the DC/DC converter can show a resonant effect which is caused by the supplying network. Especially when additional external input filters are utilized, a superimposed AC voltage can be generated on the input terminals of the DC/DC converter which might cause a malfunction of the unit. Therefore, additional input filters are not recommended. To avoid the resonant effects, the minimal resistance of the supplying network which depends on the inductance of the input network, shall be above the boundary curve in Fig. 22-3.

Fig. 22-3 External input filter requirements to avoid filter instabilities

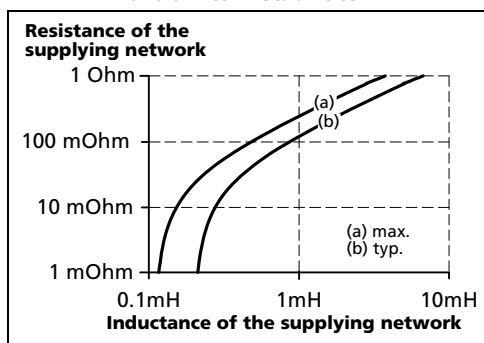

22.7. SERIES OPERATION

DC/DC converters of the exact same type can be connected in series for higher output voltages. It is possible to connect as many units in series as needed, providing the sum of the output voltage does not exceed 150Vdc. Voltages with a potential above 60Vdc are not SELV any more and can be dangerous. Such voltages must be installed with a protection against touching. Earthing of the output is required when the sum of the output voltage is above 60Vdc.

Avoid return voltage (e.g. from a decelerating motor or battery) which is applied to the output terminals.

Keep an installation clearance of 15mm (left / right) between two DC/DC-converters and avoid installing the DC/DC-converters on top of each other. Do not use DC/DC-converters in series in mounting orientations other than the standard mounting orientation (input terminals on the bottom and output terminals on top of the unit).

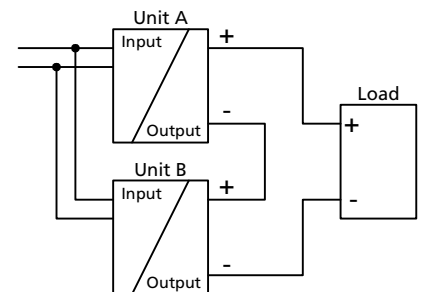

22.8. PARALLEL USE TO INCREASE OUTPUT POWER

The DC/DC-converter can be paralleled to increase the output power. There are no feature included which balances the load current between the DC/DC-converters. Therefore some restrictions and limitations apply. The DC/DC-converter with the higher adjusted output voltage draws current until it goes into current limitation. This means no harm or switch-off to this DC/DC-converter as long as the ambient temperature stays below 45°C.

The output voltages of all DC/DC-converters shall be adjusted to the same value ($\pm 100\text{mV}$) at full load. A fuse or diode on the output of each unit is only required if more than three units are connected in parallel. This avoid that more than 2 times of the nominal output current can flow backwards into the DC/DC converter in case the output stage of the DC/DC converter has a defect. If a fuse (or circuit breaker) is used, choose one with approximately 150% of the rated output current of one DC/DC-converter.

Keep an installation clearance of 15mm (left / right) between two DC/DC-converters and avoid installing the DC/DC-converters on top of each other. Do not use DC/DC-converters in parallel in mounting orientations other than the standard mounting orientation (input terminals on the bottom and output terminals on top of the unit).

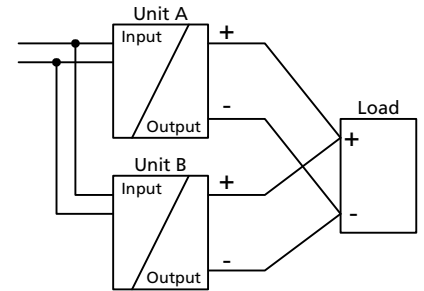

22.9. PARALLEL USE FOR REDUNDANCY

The DC/DC converters can be paralleled for 1+1 redundancy to gain higher system availability. Redundant systems require a certain amount of extra power to support the load in case one DC/DC converter fails. The simplest way is to connect two DC/DC converters in parallel. This is called a 1+1 redundancy. In case one DC/DC converter fails, the other one is automatically able to support the load current without any interruption. Redundant systems for a higher power demand are usually built in an N+1 method. E.g. five DC/DC converters, each rated for 10A are paralleled to build a 40A redundant system.

Furthermore, 1+1 redundant systems can be built by using a DC/DC converter powered from a battery and a power supply with AC input.

Please note: This simple way to build a redundant system does not cover failures such as an internal short circuit in the secondary side of the DC/DC-converter. In such a case, the defect unit becomes a load for the other DC/DC-converters and the output voltage can not be maintained any more. This can only be avoided by utilizing the redundancy module YR20.246, which utilized MOSFETs as decoupling devices.

Recommendations for building redundant power systems:

- Use separate input fuses for each DC/DC-converter.
- Monitor the "Redundancy OK" relay contact of the YR20.246. This feature reports a faulty DC/DC converter or problems with the redundancy modules.
- 1+1 Redundancy is allowed up to an ambient temperature of 60°C
N+1 Redundancy is allowed up to an ambient temperature of 45°C
- It is desirable to set the output voltages of all units to the same value ($\pm 100\text{mV}$) or leave it at the factory setting. Use the load share feature LEDs of the redundancy module to adjust the output voltages of the DC/DC converters if necessary.

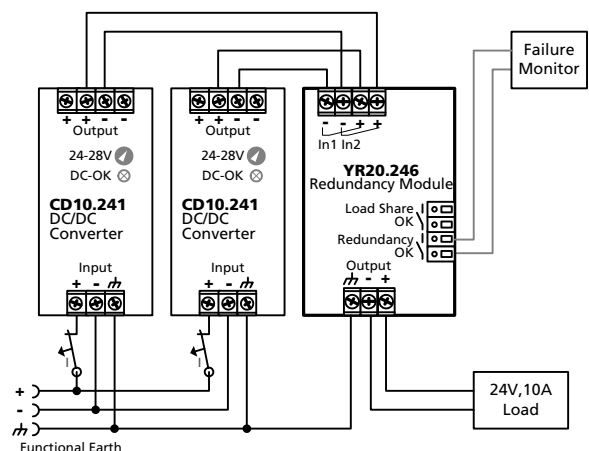

22.10. USE IN A TIGHTLY SEALED ENCLOSURE

When the DC/DC-converter is installed in a tightly sealed enclosure, the temperature inside the enclosure will be higher than outside. In such situations, the inside temperature defines the ambient temperature for the DC/DC converter.

The following measurement results can be used as a reference to estimate the temperature rise inside the enclosure.

The DC/DC-converter is placed in the middle of the box, no other heat producing items are inside the box

Condition 1: 80% load

Enclosure:	Rittal Typ IP66 Box PK 9516 100, plastic, 110x180x165mm
Load:	24V, 8A; (=80%) load is placed outside the box
Input:	24Vdc
Temperature inside enclosure:	52.2°C (in the middle of the right side of the DC/DC converter with a distance of 2cm)
Temperature outside enclosure:	31.0°C
Temperature rise:	21.2K

Condition 2: 100% load

Enclosure:	Rittal Typ IP66 Box PK 9516 100, plastic, 110x180x165mm
Load:	24V, 10A; (=100%) load is placed outside the box
Input:	24Vdc
Temperature inside enclosure:	59.3°C (in the middle of the right side of the DC/DC converter with a distance of 2cm)
Temperature outside enclosure:	31.4°C
Temperature rise:	27.9K

22.11. MOUNTING ORIENTATIONS

Mounting orientations other than input terminals on the bottom and output on the top require a reduction in continuous output power or a limitation in the max. allowed ambient temperature. The amount of reduction influences the lifetime expectancy of the DC/DC converter. Therefore, two different derating curves for continuous operation can be found below:

Curve A1 Recommended output current.

Curve A2 Max allowed output current (results in approximately half the lifetime expectancy of A1).

Fig. 22-4
Mounting Orientation A
(Standard orientation)

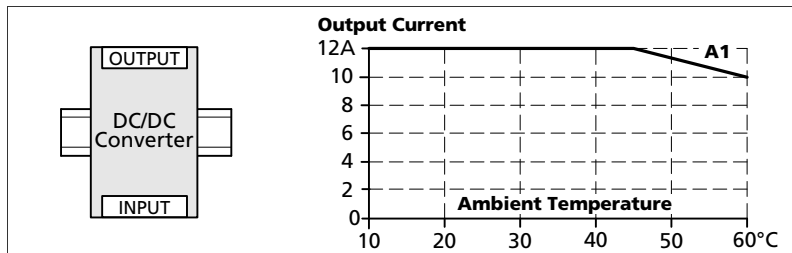

Fig. 22-5
Mounting Orientation B
(Upside down)

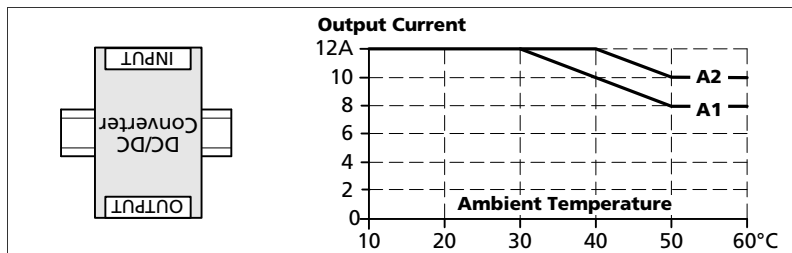

Fig. 22-6
Mounting Orientation C
(Table-top mounting)

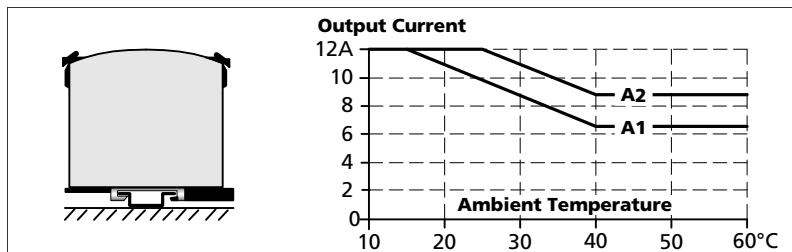

Fig. 22-7
Mounting Orientation D
(Horizontal cw)

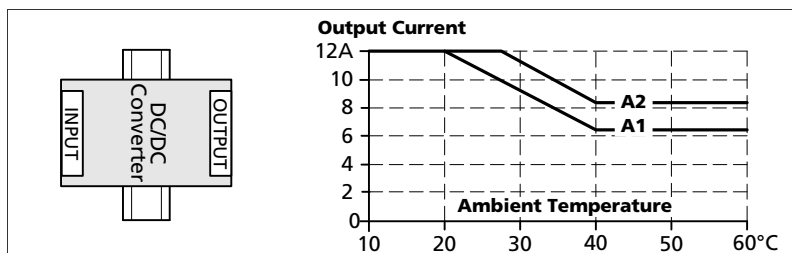

Fig. 22-8
Mounting Orientation E
(Horizontal ccw)

